

Collektor plate
Drop contour: 2-propanol,
purity 99.9%
Microscope: dark-field
vertical illumination

Collektor plate
Drop contour: 2-propanol,
targeted contami-
nation with 500 ppm
mineral oil
Microscope:
dark-field vertical illumi-
nation

Win Labuda and Stefan Haupt

Visualization of Micro Contaminants

Collector Plate for Contaminants in
Solvents, Material Imprints und Particles

Clear & Clean - Research Laboratory
revised edition 1-2018

While the term „to measure“ describes the scaled comparison of condition variables and reference variables, we know alternative, non-scaled, perceptual forms which may be sufficient or even advantageous for certain tasks. Often, the sampling and preparation of accurate measurement data of technical conditions is associated with a great deal of time and effort. In many cases, however, it would be sufficient to have the information „too much“ or „too little“ to respond to certain conditions.

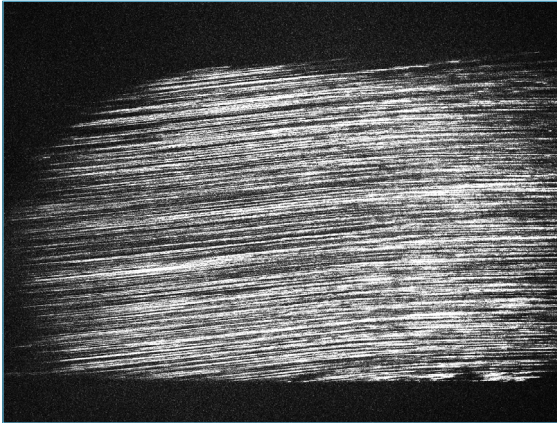

Fig. 2 Cleaning of a fingerprint with a dry polyester wiper of mesh density 300. Distinct streaks remain.

If there are normally 10 particles on a sedimentation plate in the cleanroom and at the next measuring interval there are hundreds, then the precise information is meaningless whether there are exactly 610 or 720 particles. The important information is: a lot more particles than usual – measures for restoring the original state must be initiated. In such cases, indicator methods can be superior to the sophisticated measurement methods because of the unambiguousness of their statements and their immediate availability. Furthermore, indicator methods require less investment and can often be handled by trained staff. In the Clear & Clean Research Laboratory, we are working on the development of „low-tech“ methods for use in clean technology, so that the user can test the purchased cleanroom consumables himself/herself and does not have to rely on external help. Several such methods are described below:

Purity conditions

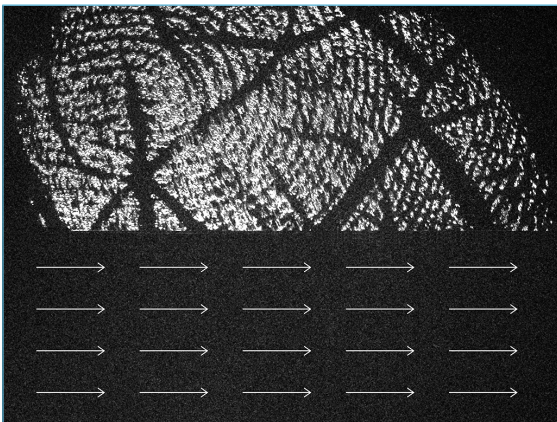
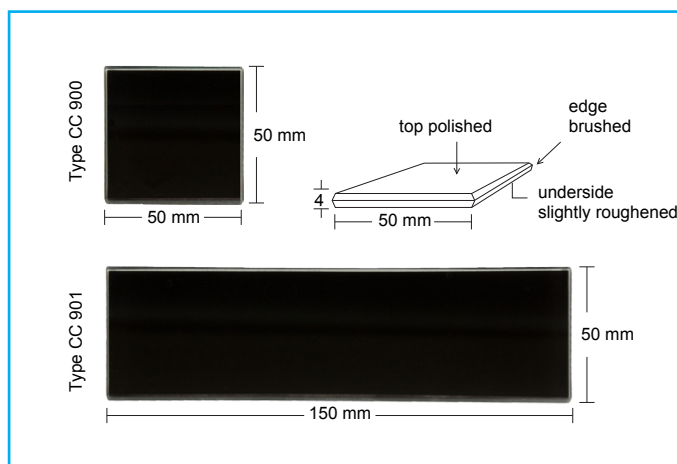

Fig. 3 Cleaning of the lower print with N-hexane and decontaminated cleaning wiper, mesh density 1056. The surface is pure.

Technologists in the high-tech industries are often dependent on detecting and correcting impurity conditions in the micro meter range. Impurities of this kind are not recognisable with the naked eye. Electronic devices are available for this purpose. These transfer “impurity” into numerical data. Their physical units are, for example, particles per unit volume or per unit area. Today it is relatively easy to measure how many particles are in a liquid or on a surface. In research or for material tests such purity data are needed for comparative purposes, for example to ensure that specified limits are strictly adhered to in a production process. However, such equipment with high measuring accuracy is not available everywhere. Moreover, it costs several thousand euros and weighs between 1 and 20 kg.

The first task was to develop a method for the rapid evaluation of solvent purity. We needed high-purity solvents to produce clean surfaces. Only through reference surfaces did it become possible to comparatively assess contamination. Technical surface cleanliness can be achieved in many cases through the use of high-purity solvents – for example, by means of cleaning rinsing processes or by wiping cleaning procedures with a solvent.

Fig. 4 The C&C-Collector plate, shape, size, texture (2 versions)



Development of an indicator system

For the development of an indicator system for the chemical purity of solvents we came across research by Bernhardt Klumpp from 1993, who in his dissertation [1] had described an interesting system for the detection of particles on surfaces by means of directed oblique light. Later we came across a work by Robert Deegan [2], in which Deegan described and analysed the so-called coffee stain ring effect:

When the drop of a liquid containing particles reaches the smooth surface of a solid and evaporates there, the particles dispersed over the entire drop become concentrated in its perimeter. They form a clearly visible zone of increased particle density. The drop edge is pinned to the substrate surface by the known adhesive forces. The challenge was to combine Klumpp's detection and image processing system with the Mie scattering as the basis and the coffee ring stain effect. We suspected that in combining the systems, not only solid particles could be imaged, but above all also non-volatile residues of liquid phases. These are obtained, for example, from the distillation of solvents such as acetone, 2-propanol, n-hexane or benzene. We hypothesised that they could be visualised microscopically in the compaction zone as ring-shaped drop-edge structures if we placed them on a black-coloured substrate and illuminated them with directed oblique light. The experiment confirmed our hypothesis. In order to increase the image contrast, we first coated the black-coloured glass substrate with an iridium layer so that we could reduce the reflection of the glass surface to below 3%, thus achieving a significant increase in the contrast of the image. The disadvantage of these plates is that they are very scratch-sensitive. We searched and found glass that was more scratch resistant, but provided a slightly lower contrast, which we now use.

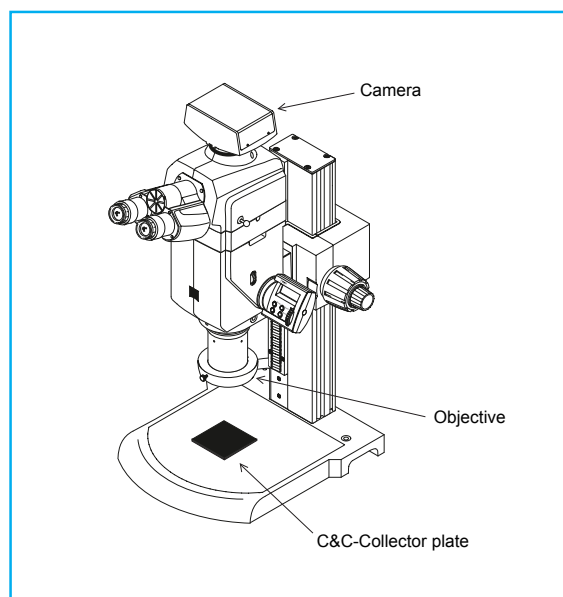

Fig. 5 Microscope Zeiss Axio Zoom.V16-dark-field-contrast

Our task consisted mainly of four specific objectives:

- 1- the microscopic visualization of non-volatile residues in basically pure liquids such as solvents

- 2- the microscopic visualization of imprints of such materials on the surface of which transferrable films or particles or other contaminants are found
- 3- the imaging of streaks as they occur in the inadequate execution of wiping cleaning procedures
- 4- the microscopic visualization of solid particles in the dark-field contrast or in the directed oblique light on black-coloured glass plates

In addition, we wanted to prove experimentally that by the controlled dipping of textile materials in high-purity solvents, a statement could be made about their contaminant mass due to textile finishing agents or other substances.

Materials, devices and software

- Clear & Clean – collector plate 50 x 50 or 50 x 150 mm
- Zeiss Microscope Axio Zoom V16 – Vertical Illumination-Dark-Field-Contrast
- Zeiss Objectives PlanApo Z1x/0.25 FWD 60 mm
- Zeiss Microscope Camera AxioCam 105 Color
- Zeiss Microscope Software AxioVision
- Analytical 2-propanol 99.8%
- n-hexane 99 % solvent
- Ballistol universal oil
- Microliter pipette 0.1 - 3 μ l
- Airlaid – wiper type Kimtech Science 7557 for plate cleaning

To determine to what extent the degree of purity of the solvent affects the depicted drop edges, analytical, high-purity 2-propanol is contaminated by light mineral oil. In this experiment, contamination levels of 0.001 - 1% were obtained.

Execution of the experiment

The collector plate is thoroughly cleaned and examined for residual contaminants by means of n-hexane 99% and a

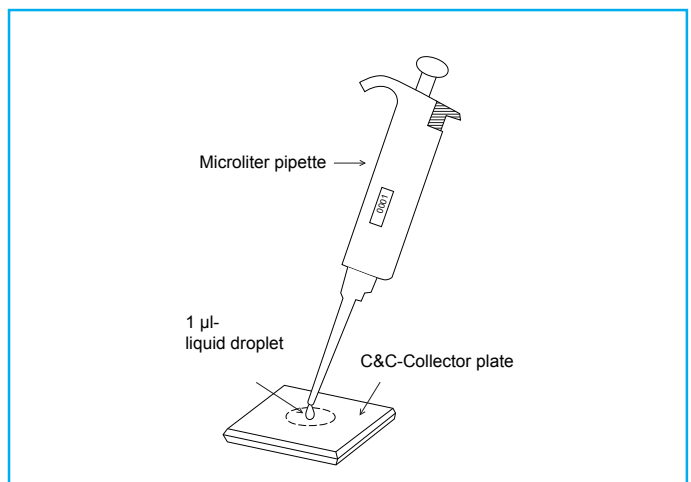
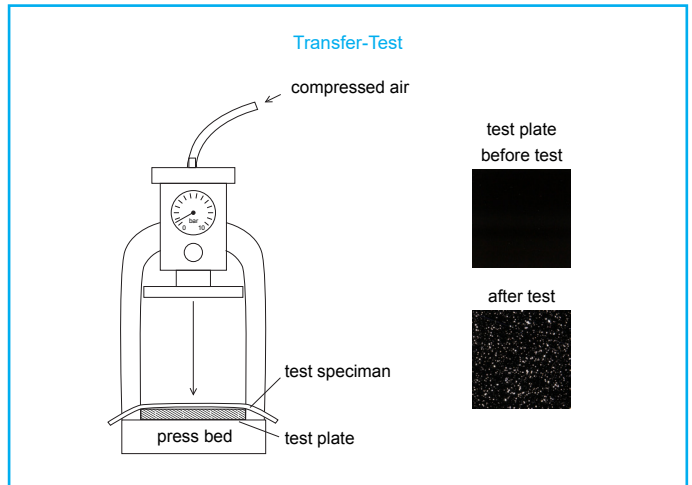

Fig. 6 Application of liquid by pipette 0-1 μ m

Fig. 7 Particle transfer by means of CC Transfer Test (material imprint)



Kimtech Science nonwoven wiper before the start of the experiment. If no contamination is visible under the dark-field vertical illumination microscope, the experiment can begin.

Applying the drop

Using a pipette, 1 μl is taken from one of the previously mixed samples and placed as centrally as possible on the collector plate. The droplet must be placed on the collector plate without contact between the plate and the pipette cannula. The tip of the microliter pipette must then be disposed of.

Visualization

To make the drop edge visible, it is necessary to use oblique light. By means of the microscope and camera the drop edge can then be photographed and analysed.

Drop edge

With software such as Zeiss AxioVision, the drop edge can also be measured. Afterwards, the results are stored and are available for further processing.

Fig. 8 Particle residue on collector plate (cleanroom wiper Microweb®-UDG)

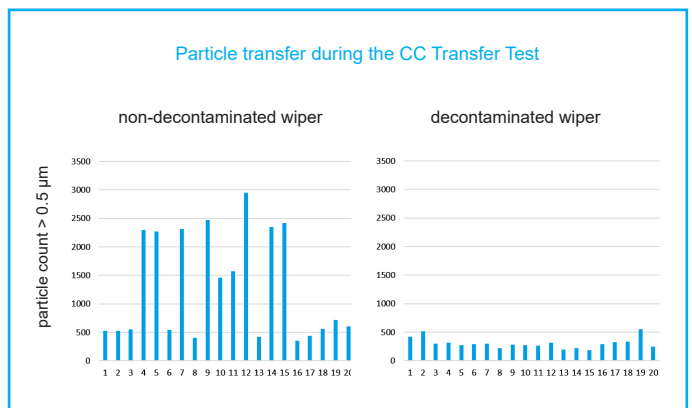

Visualization of contaminants in solvents

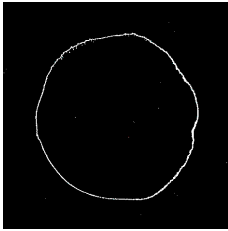

2-propanol, purity 99.9%, dark-field vertical illumination, in the pure state

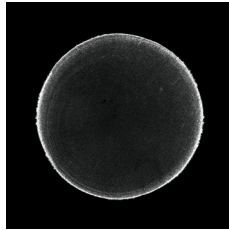

2-propanol, purity 99.9%, Contamination with 500 ppm mineral oil, dark-field vertical illumination

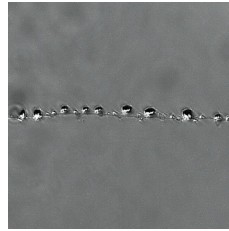

analytical 2-propanol, purity 99.9%, 100-fold magnification of the edge region

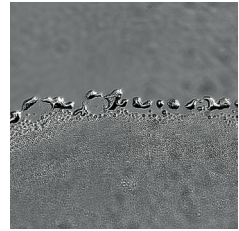

Additional contamination with 500 ppm mineral oil, 100x magnification of the edge

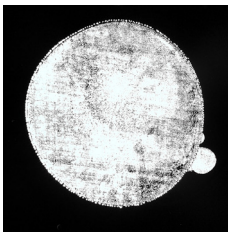

Additional contamination with 5000 ppm mineral oil, 10x magnification of the droplet

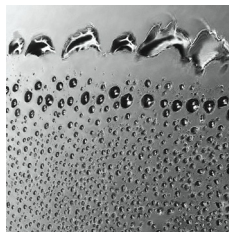

Additional contamination with 5000 ppm mineral oil, edge segment, 100x magnification



0 / 30-2-propanol DI water mixture, droplet image, 10x magnification

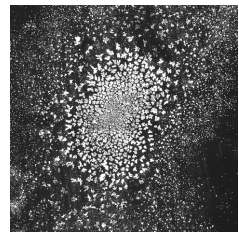

70 / 30-2-propanol DI water mixture, segment, 100-fold magnification

Visualization of material imprints through imprint or residue formation

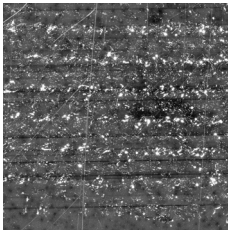

Textile imprint after pressing a cleanroom wiper onto the C & C collector plate

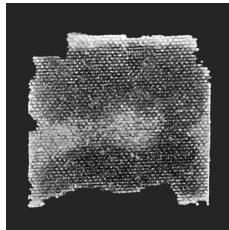

Knit oil residues after acetone bath, residue on C & C collector plate



After imprint of polyester cellulose wiper (few particles)



After imprint of decontaminated knitted wiper (hardly any particles)

Visualization of streaks caused by wiping processes

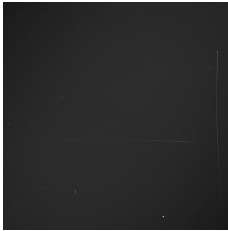

Wiping of a fingerprint with decontaminated wiper, mesh density 1056 = no residues



Wiping of a fingerprint with non-decontaminated cleaning wiper, mesh density 400 = no residues

Visualization of particle Sedimentation from the air

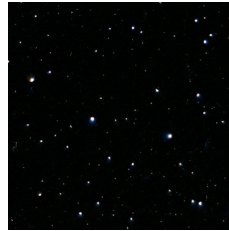

Particle sedimentation after 1 hour

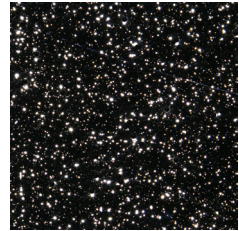

Particle sedimentation after 24 hours

Results

- The experiments showed that the rough assessment of solvent contamination is possible by measuring the particle density at the drop edge.
- Material imprints transferred to the collector plate reveal the purity of product surfaces (overalls, clean room wipers, gloves, and other flexible fabrics).
- Distinct streaks were found after cleaning by wiping operations, depending on the degree of decontamination of the cleanroom wipers used.
- The collector plate is ideally suited for the visualization of particulate contaminants such as sedimentation.

The advantage of the described collector methods lies in their universal applicability, simplicity, speed, and in their relatively low price. In particular, the estimation of the mass of non-volatile residues in pure solvents is possible only with much greater effort by measurement technology. The drawback of these indicator methods is their lack of scalability. These are indication methods, not measurement methods.

(Stefan Haupt gave a lecture on this topic at the „Lounges 2017“ trade fair in Stuttgart on January 31th, 2017 and another on January 6th, 2018 at the „Lounges 2018“ in Karlsruhe.)

Bibliography

- [1] Klumpp, Bernhardt „Prüfverfahren zur Untersuchung der Partikelreinheit technischer Oberflächen“ (Test Methods for the Investigation of the Particle Purity of Technical Surfaces), „Forschung und Praxis“ Vol. 182, Springer Verlag 1993
- [2] Deegan, R.D. et al. Nature 389, 827-829
- [3] Shen Xiaoying, Ho Chih-Ming, Wong Tak-Sing „Minimal Size of Coffee Ring Structure“, Journal of Physical Chemistry - 2010
- [4] Labuda, Win, „Substrat zur Sichtbarmachung von daran angelagerten Partikeln und/ oder Materialschichten“ (Substrate for the Visualization of Particles and / or Material Layers Deposited There) Patent document DE 10016832 C2 (April 3, 2000)
- [5] Hühnerfuß, Bianca „Literaturrecherche zum Kaffeeringeffekt“ (Research of the Reference Literature on the Coffee Stain Ring Effect), undergraduate paper, TU Chemnitz, Faculty of Mechanical Engineering, Institute of Print and Media Technology, 2009.
- [6] McDonagh, A., Sextro, R. G., Byrne, M. A. „Mass transport of deposited particles by surface-to-surface contact“ Journal of Hazardous Materials 227-228 (2012)370-377

Translation: Carol Oberschmidt